

HONKA

Installation, operation & maintenance manual



Dear Customer, Thank you for purchasing an ORANS sauna. We hope you will be fully satisfied with your purchase. Please remember that this manual is an important document of reference and should be provided by the seller with the sauna. ORANS forbids the reproduction of any part of this manual. Each sauna is checked and tested thoroughly at our premises prior to delivery to ensure its correct working order and the absolute reliability of its safety devices. Should you require any further information or clarification, please contact your local dealer or contact our company directly.



TWO PEOPLE ARE NECESSARY!

It indicates a procedure for which two people are required. Otherwise, the product or other objects in the surroundings may be damaged.



INSTALLER FOR ELECTRICAL SUPPLIES

Technician specialised in installing the product in ordinary work conditions. He is competent for all the interventions concerning the electrical supplies such as registrations, maintenance and repairs. He is skilled for interventions in electrical boards or electrical outlets which are under power.

some information or pictures in this manual may show details and spare parts which may be slightly different from the ones of your infrared Sauna room: however, the primary information remains unchanged. Following our constant search for improvements, the infrared Sauna room may show some changes which are not included in this manual.



ORANS refuses all responsibility for damages caused by an inappropriate use of the infrared sauna. ORANS reserves the right to institute legal proceedings against those who make any changes to its infrared Sauna room without previous written authorisation.

PROCEDURE:

The installation must be done by qualified people based on the information given in this manual and in accordance with national regulations and standards. Upstream of the electrical power system, you must install a CLASS "A" GROUND FAULT CIRCUIT INTERRUPTER.



Users must be fully informed about how to use it.



Read this manual carefully before using the infrared Sauna room.

SAFETY WARNINGS



Observe the instructions for use.



Attention
Covering the heater or infrared emitter causes danger of fire!



Do not use infrared sauna room longer than approx. 30 to 60 min. (according to your personal health).



Avoid continuous exposure to the eyes and respect a direct minimum distance of about 70 cm between the infrared radiator and eyes.



Ill people or people subject to a risk of overheating, such as people suffering from cardiovascular diseases, should ask a doctor, in case of doubt, before using an infrared cabin.



If you belong to a group of people with limited heat sensitivity or are under the effects of alcohol or tranquilizers, the infrared cabin should not be used.



Not to be used by people who are helpless and sensitive to heat or by small children.



We recommend not to use the infrared cabin within 24 h after UV radiation from an artificial source or after sunbathing.



Do not rub your skin intensively or take drugs, which stimulate the blood circulation of the skin, before using the infrared sauna room.



If you feel the heat too much on your skin, change your sitting position or leave the cabin.



Attention:

If a prolonged erythema (constant redness of the skin for more than a day) or net-like changes in colour after regular radiation with infrared appear, do not repeat radiation anymore and consult your doctor, in order to prevent the development of an erythema ab igne.

SAFETY WARNINGS



Place the cabin only on safe foundations, which is resistant to humidity (e.g.: tiles).



Only experts are allowed to perform repair works.



CAUTION: USE ONLY A CONTACTOR APPROVED FOR 250,000 ENDURANCE CYCLES.



Take the mains plug out of the socket before opening the controls or exchanging the heating elements.



Caution: Fire risk in the case of a broken emitter.



This device may be used by children at the age of 8 years and older and by persons with limited physical, sensorial or mental capabilities or lack of experience and knowledge, if they have been supervised or instructed in the safe use of the device and are understanding the hazards arising therefrom. Children are not allowed to play with the device. Cleaning and user maintenance must not be performed by children without supervision.



Do not put up near bath tubs and showers (minimum distance approx.: 60 cm). The safety regulations according to VDE100, especially VDE100-702 have to be observed. Observe the distances to swimming pools according to ÖVE EN1 and safety regulations according to VDE100-703.



The cabin is not suitable for public places, which are freely accessible and without regular supervision (e.g.: residential blocks, hotel without reception,...).



Always put the cabin in enclosed rooms - never in the open air.



When this heater is not installed for use with an attendant or is controlled by remote with APP, a timed-cutoff switch must be connected in the input circuit to disconnect all ungrounded conductors of the heater circuit from the supply source at the end of 1 hour of operation. The timed-cutoff switch must be located outside the heater room, or mounted on a wall or door inside the heater room. The time feature of the switch must not lend itself to being overridden.

UNPACKING

IMPORTANT. After removing the packaging, check that all the items and materials are complete and undamaged. If damage has been caused during transport, the carrier must be notified within the legal periods as not to forfeit the insurance cover.

Infrared sauna room Hygiene

Each time the sauna is used, we recommend cleaning both the slatted floor boards and the benches that have been used so as to guarantee, among other things, correct hygiene of the product.

The wooden surfaces of the sauna must never be chemically treated, not even with common varnish or paint, since it would negatively affect the natural characteristics of the wood and on the one hand would make the sauna totally ineffective and on the other would give rise to risk of severe burns to the body.

Clean the sauna cabin with a wet cotton cloth and dry it with a clean, dry cloth regular cleaning ensures the long life of the sauna NO complaints are accepted in respect of certain natural imperfection in the wood such as slight colour tone variations or small cracks or splits.

All measurements are in mm.

1000x1050x2160(mm)

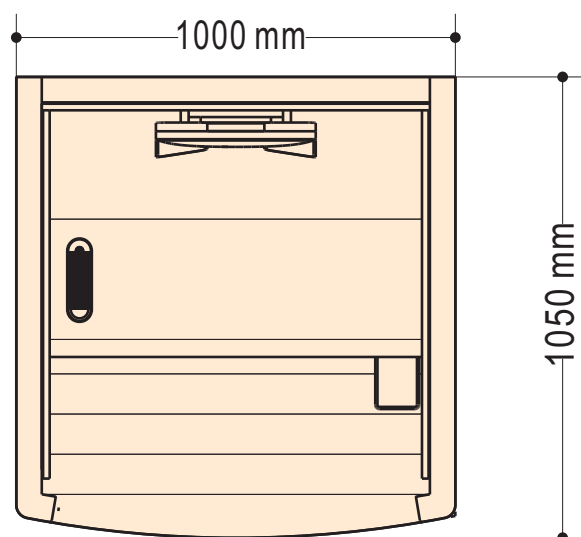
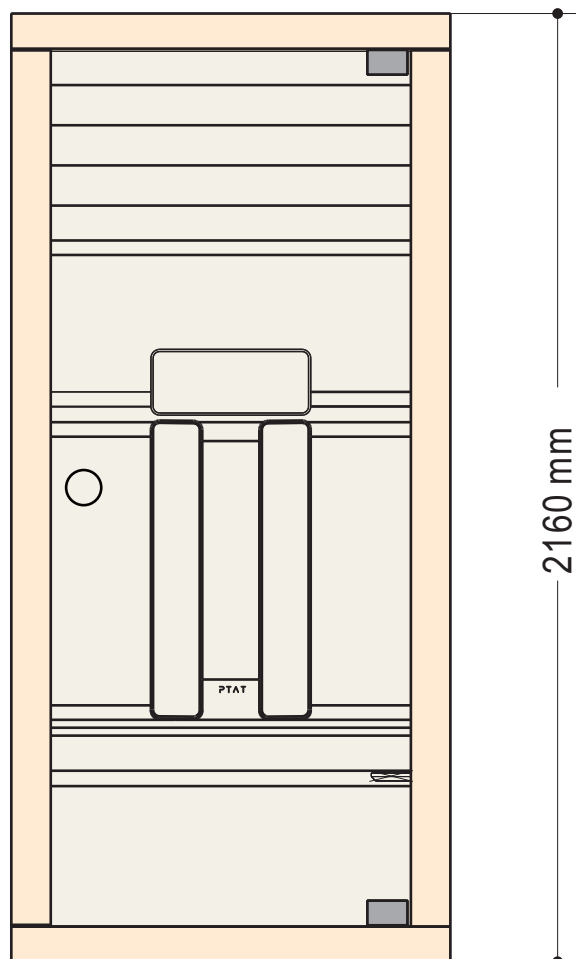

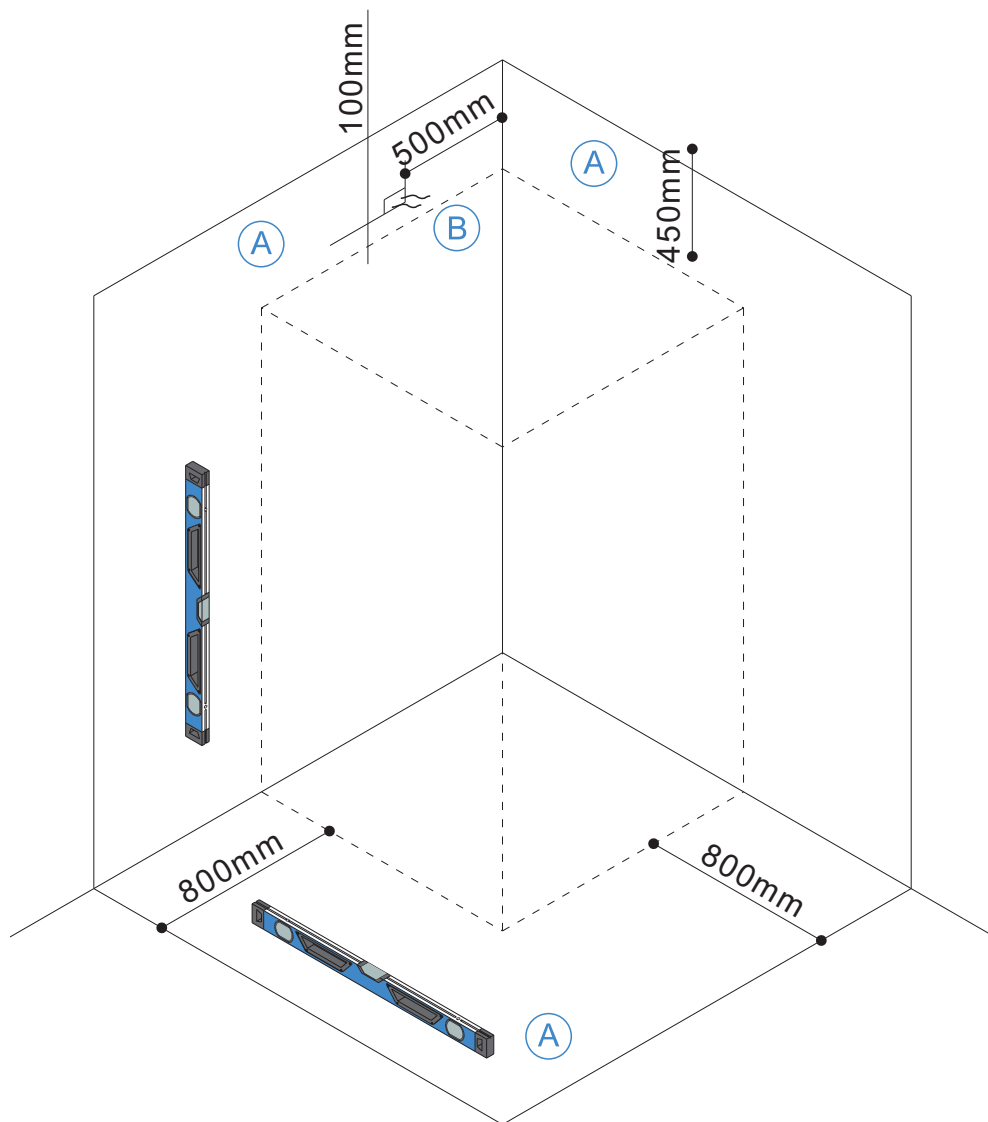

Ⓐ Space required around the sauna for easy assembly. If a smaller area is available, please contact the manufacturer.

Ⓑ Sauna power cable.

EN ELECTRICAL SAFETY:

ORANS saunas are manufactured and tested in compliance with European regulations to ensure the utmost safety for users.

ELECTRICAL CONNECTION:

The sauna must be connected to the power grid using a CLASS "A" GROUND FAULT CIRCUIT INTERRUPTER adequate for the power consumption of the product. The AC electrical connection must be:

- fixed;
- adequate for the current absorbed.

If the sauna is installed in a bathroom, the following requirements must be met:

- the CLASS "A" GROUND FAULT CIRCUIT INTERRUPTER must be placed outside the wet zone.
- the AC electric connection must be protected from water.

In any case, always comply with the requirements of the national regulations with regards to the position of the electrical elements.

N.B.

The product must be installed in an area with finished floors and walls.

Technical specifications				
Model	Power (KW)	Min.cross-section of elec.conductors (mm ²)	Electric intensity (A)	Voltage (V)
HONKING	2.3	2.5	10A	220-240 Vac 1N 50 Hz

EN ATTENTION:

Connect the ORANS sauna to the mains using a H07NR-F power cable with a suitable cross-connection (see nameplates).

Install a Class "α" ground fault circuit interrupter upstream on the power supply line to the sauna. Refer to the rating plate of the sauna to be installed for the sizing of the power supply components (voltage, current, maximum power consumption, line protection fuse).

IMPORTANT:

If you need to replace the power supply cable, Contact an approved service centre.

IMPORTANT:

If you need to replace the power supply cable, be sure to make the connection (fixed) between the power supply cable itself (type H07NR-F) and the feeding line respecting, the polarities indicated by the respective symbols placed on the terminal board of the heater: L=phase, N=neutral connected to the light blue coloured wire, = the main ground terminal connected to the yellow-green wire. At the end of the new power supply cable installation, you have to seal the upper opening in order to prevent dust and liquid from entering through the passage of the power supply cable.

It is compulsory to fix the connection of the sauna ground wire to an efficient safety ground terminal.

Installation and positioning in the bathroom area is permitted, provided that the local regulations in force are complied with, away from splashes or jets of water.

Always observe all the hazard warnings and safety regulations issued by the relevant authorities in each country.

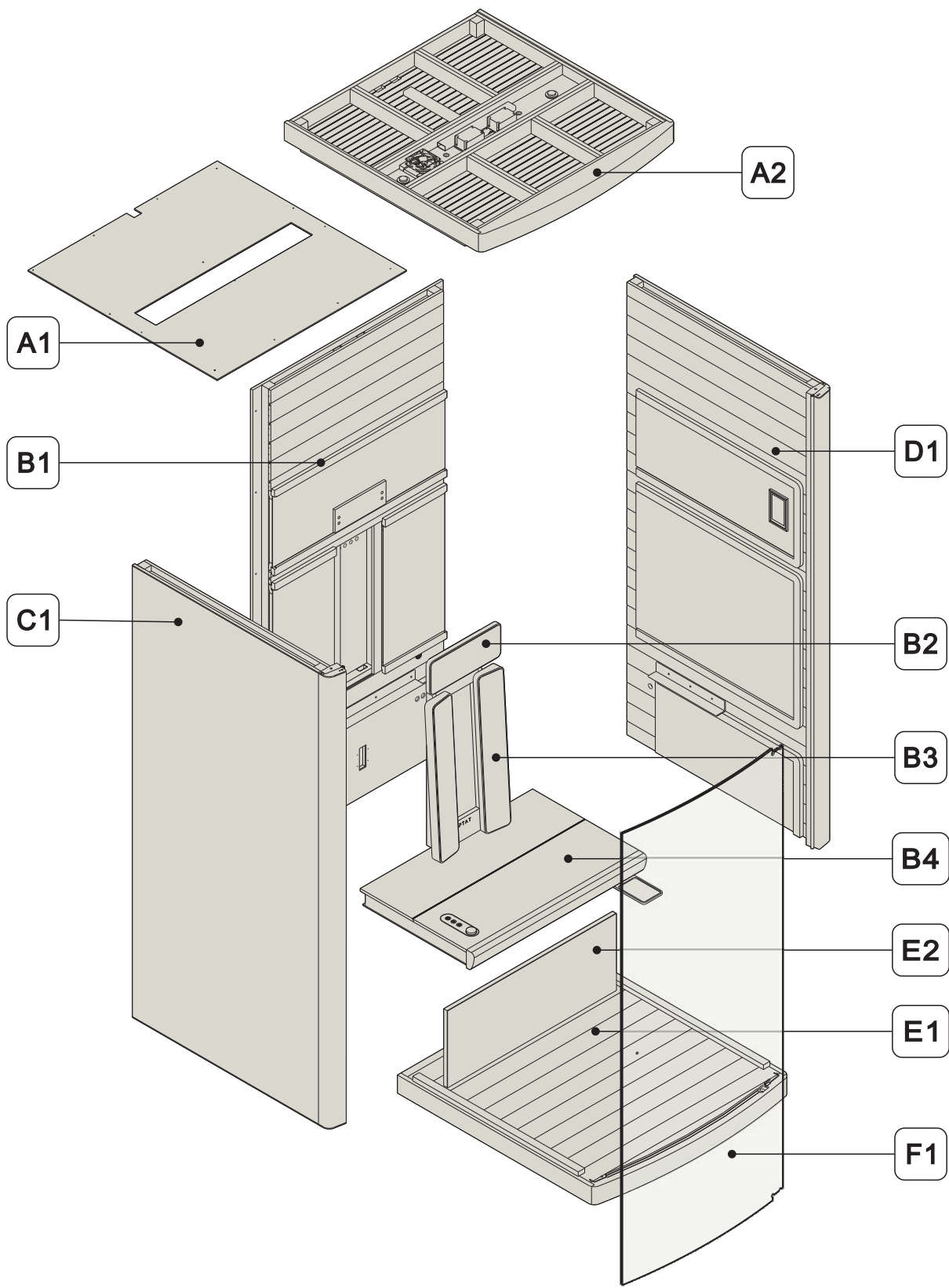

Parts List

The parts below are numbered with the letter corresponding to their elements (wood panels, window..)

A3	2 Pcs.	A4	4 Pcs.	C2	14 Pcs.
----	--------	----	--------	----	---------

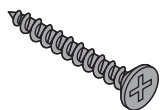

ST4*45

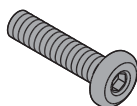

M6*70



ST4*16

C3	12 Pcs.	D2	6 Pcs.	F2	1 Pcs.
----	---------	----	--------	----	--------

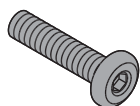

M6*25

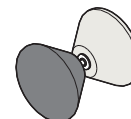

F3	1 Pcs.	F4	1 Pcs.
----	--------	----	--------

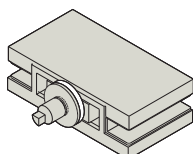

Lower axis

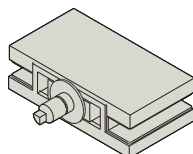

Up axis

Product installation tools

a	1 Pcs.	b	1 Pcs.	c	1 Pcs.	d	1 Pcs.
---	--------	---	--------	---	--------	---	--------

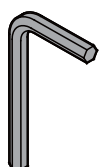
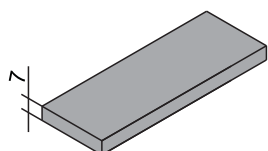

H4

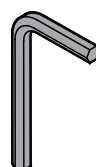

H3

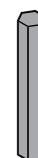

H4

e	1 Pcs.
---	--------

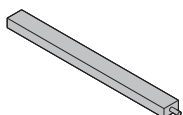

L=380mm

Tools required for installation(not supplied)

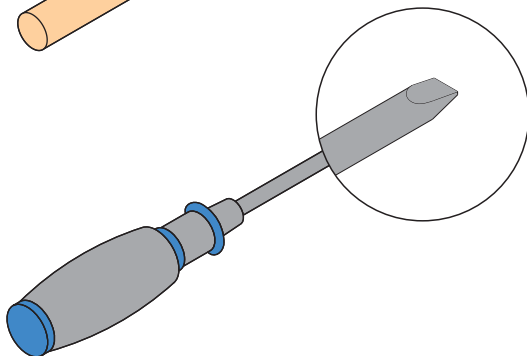
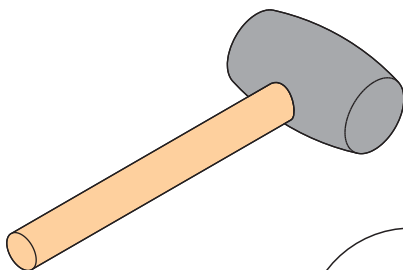
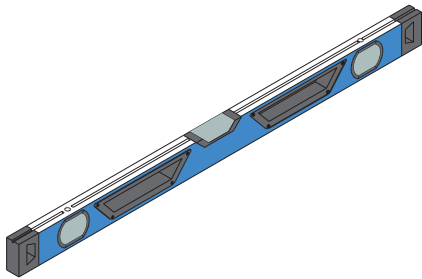
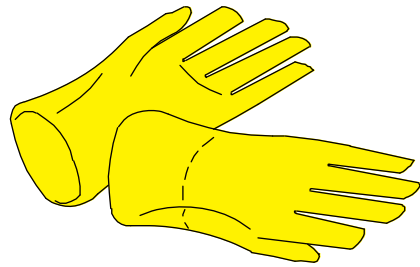
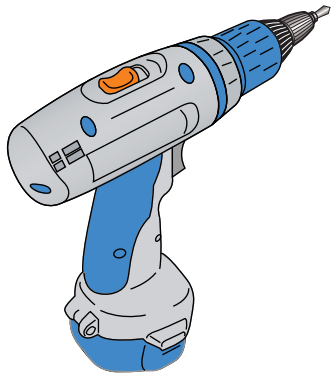

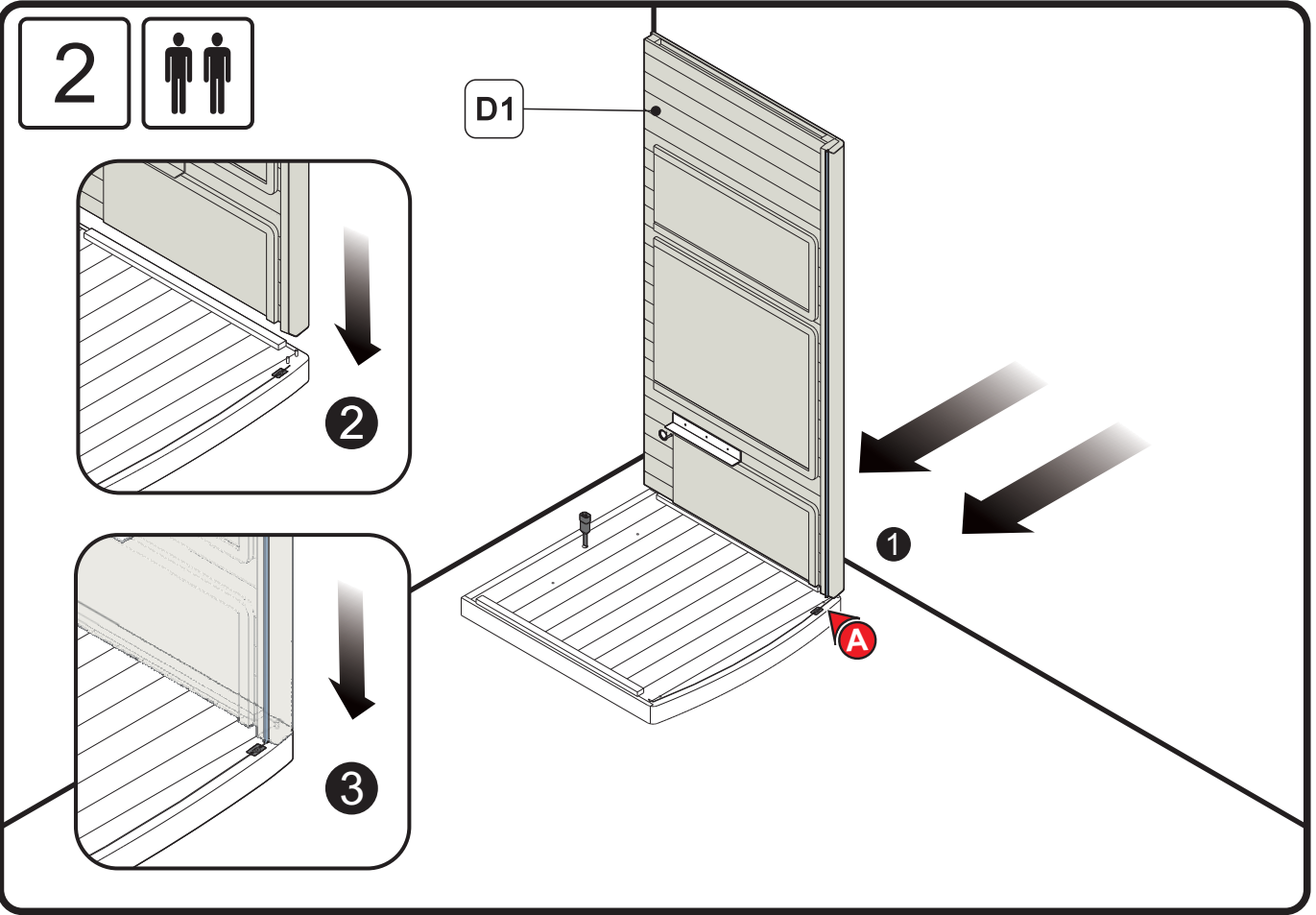
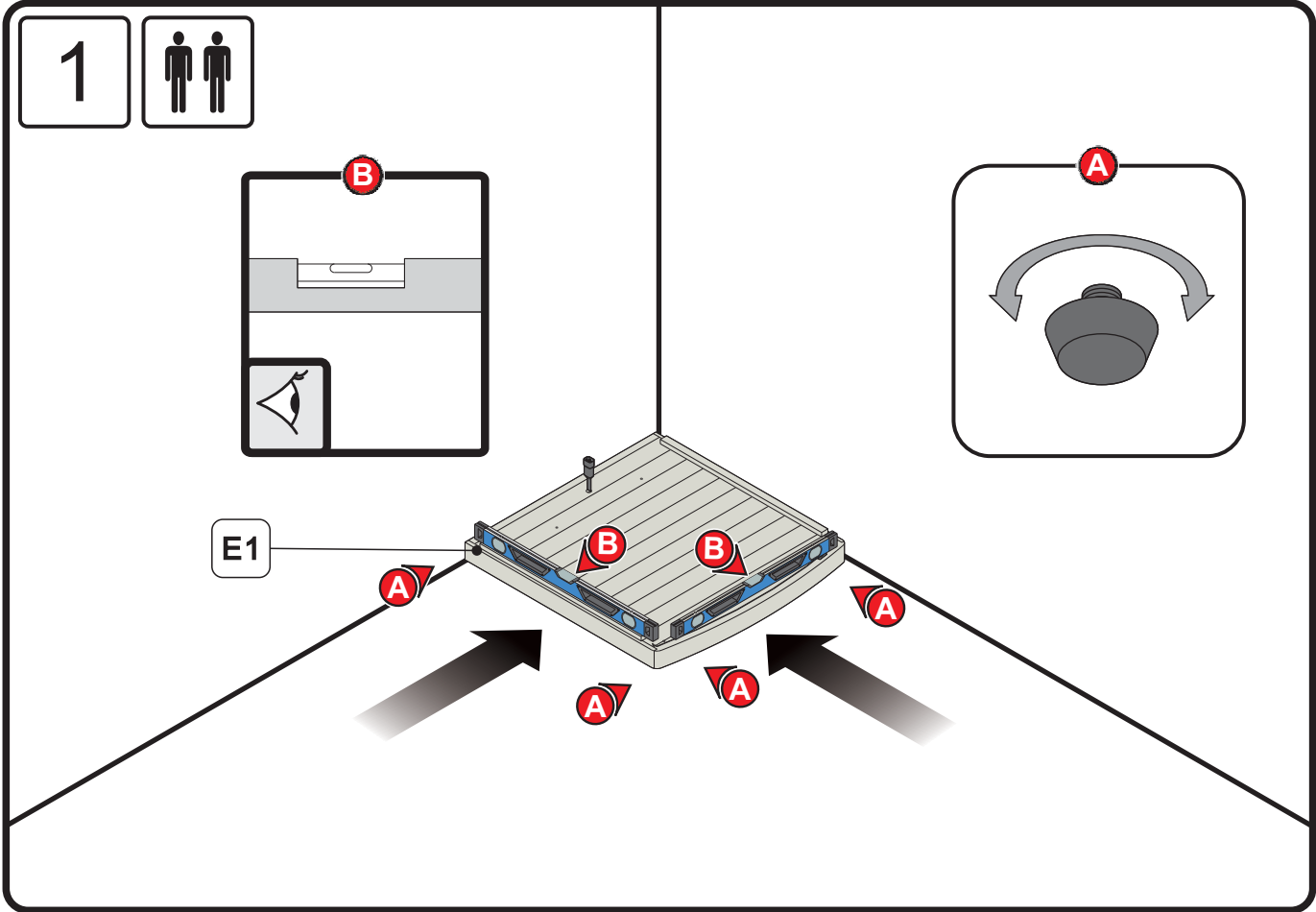

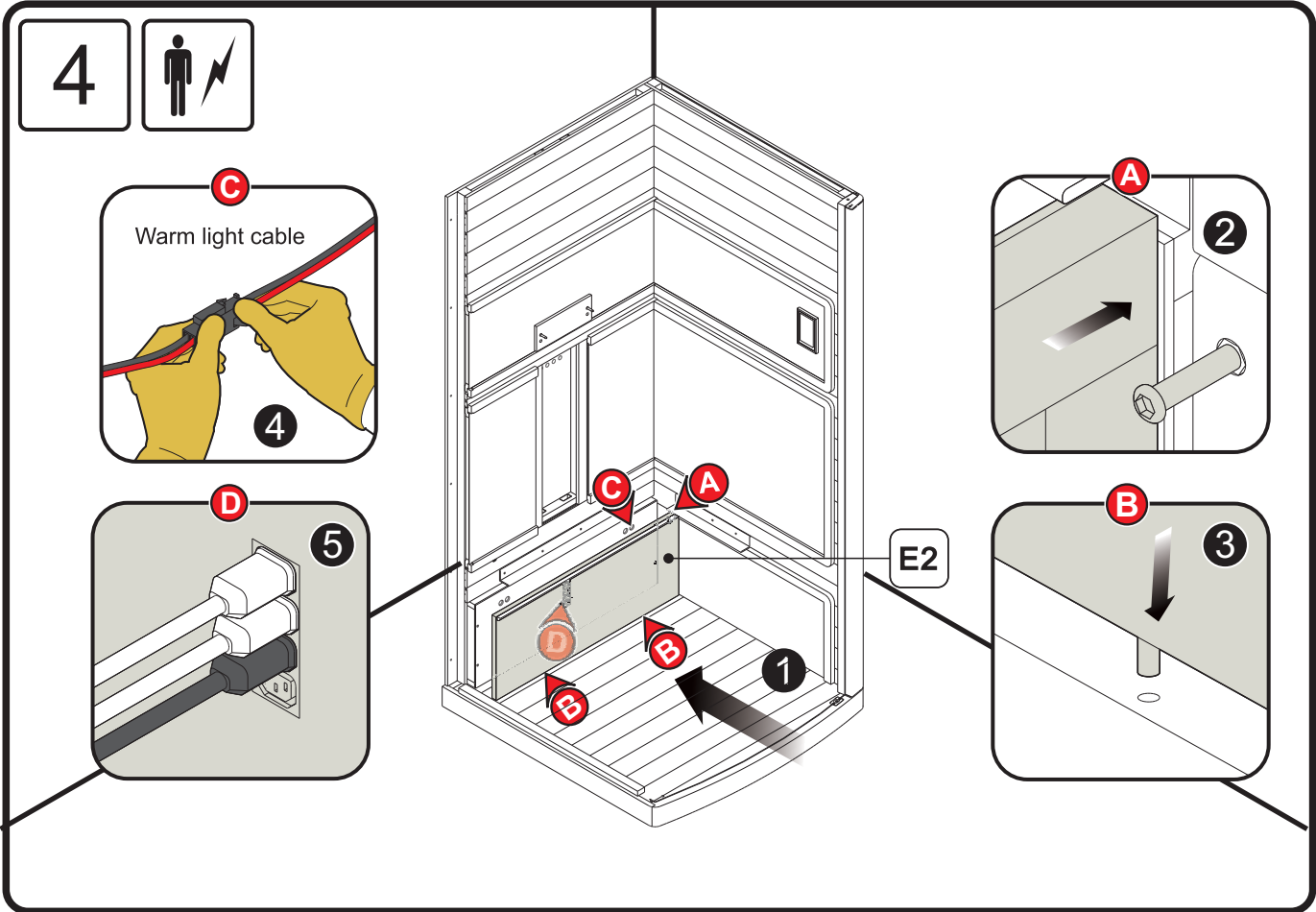
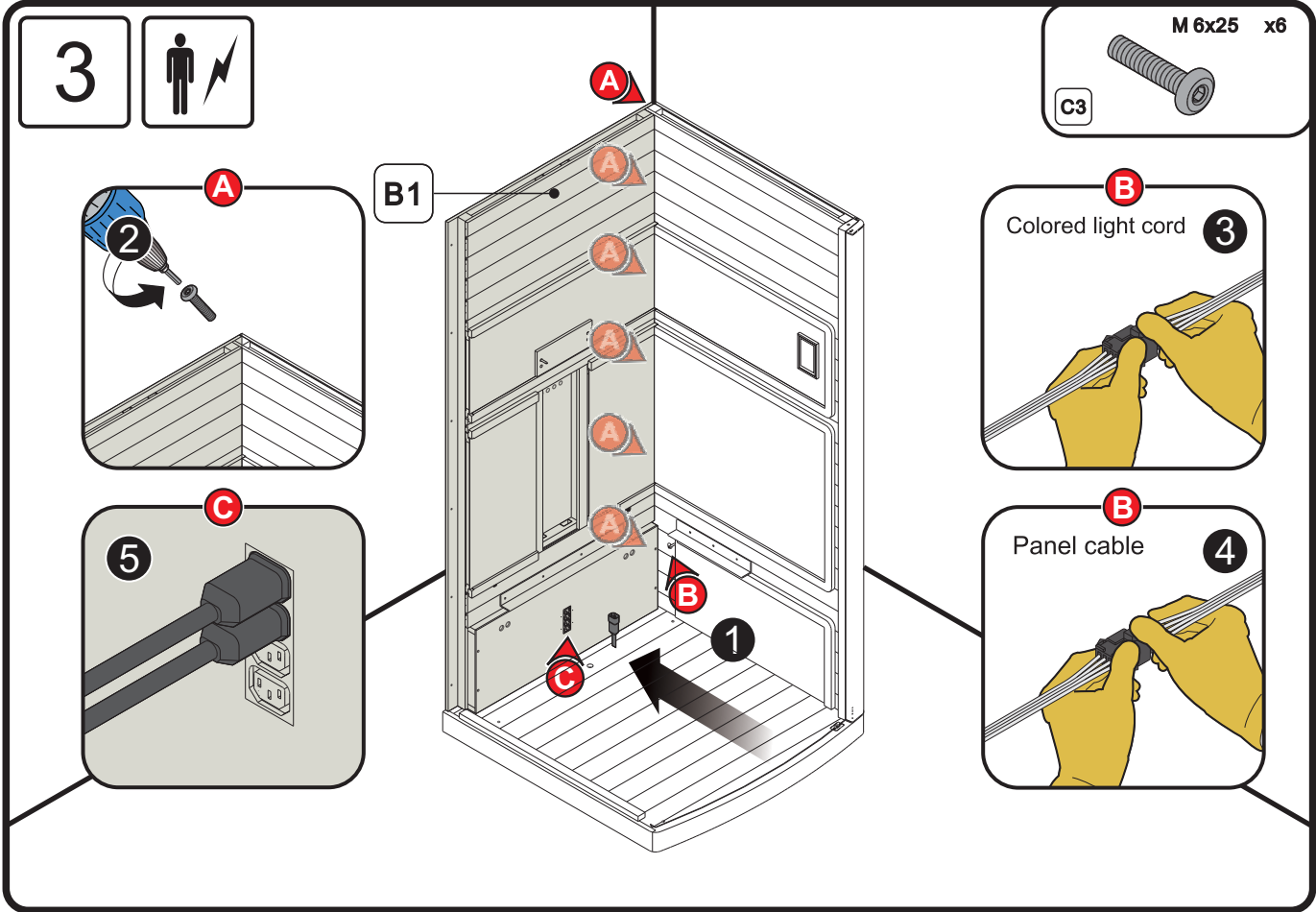

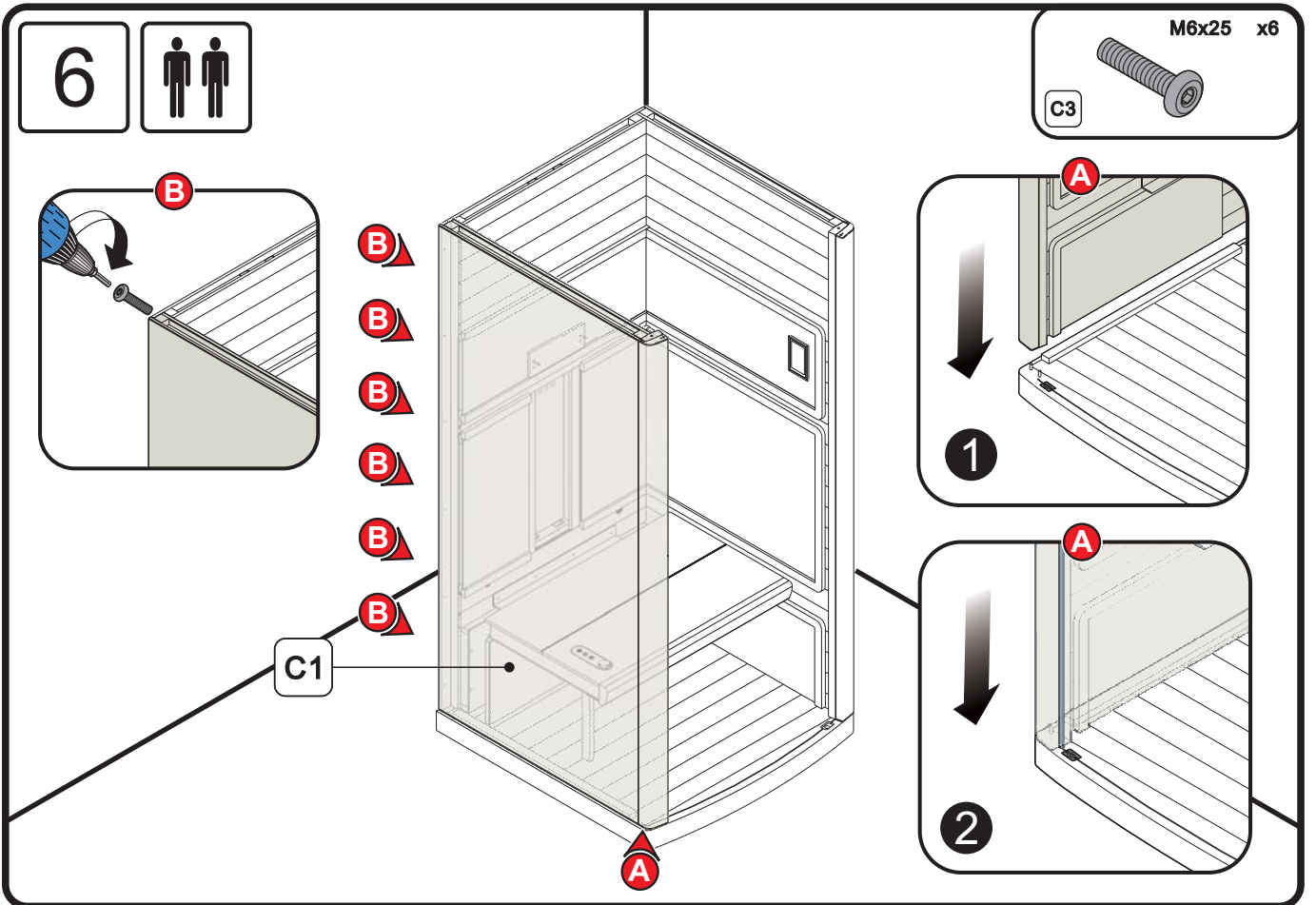
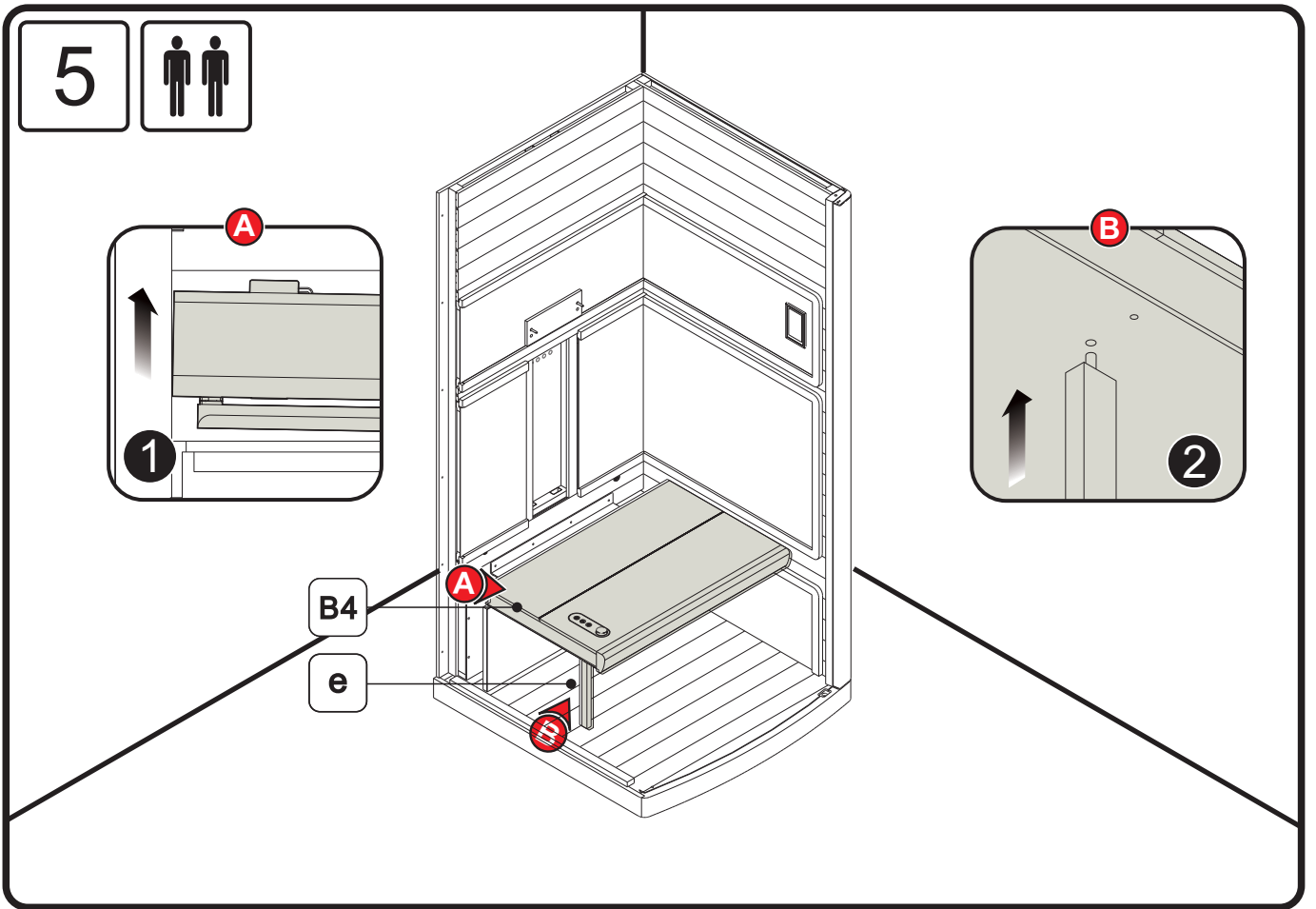

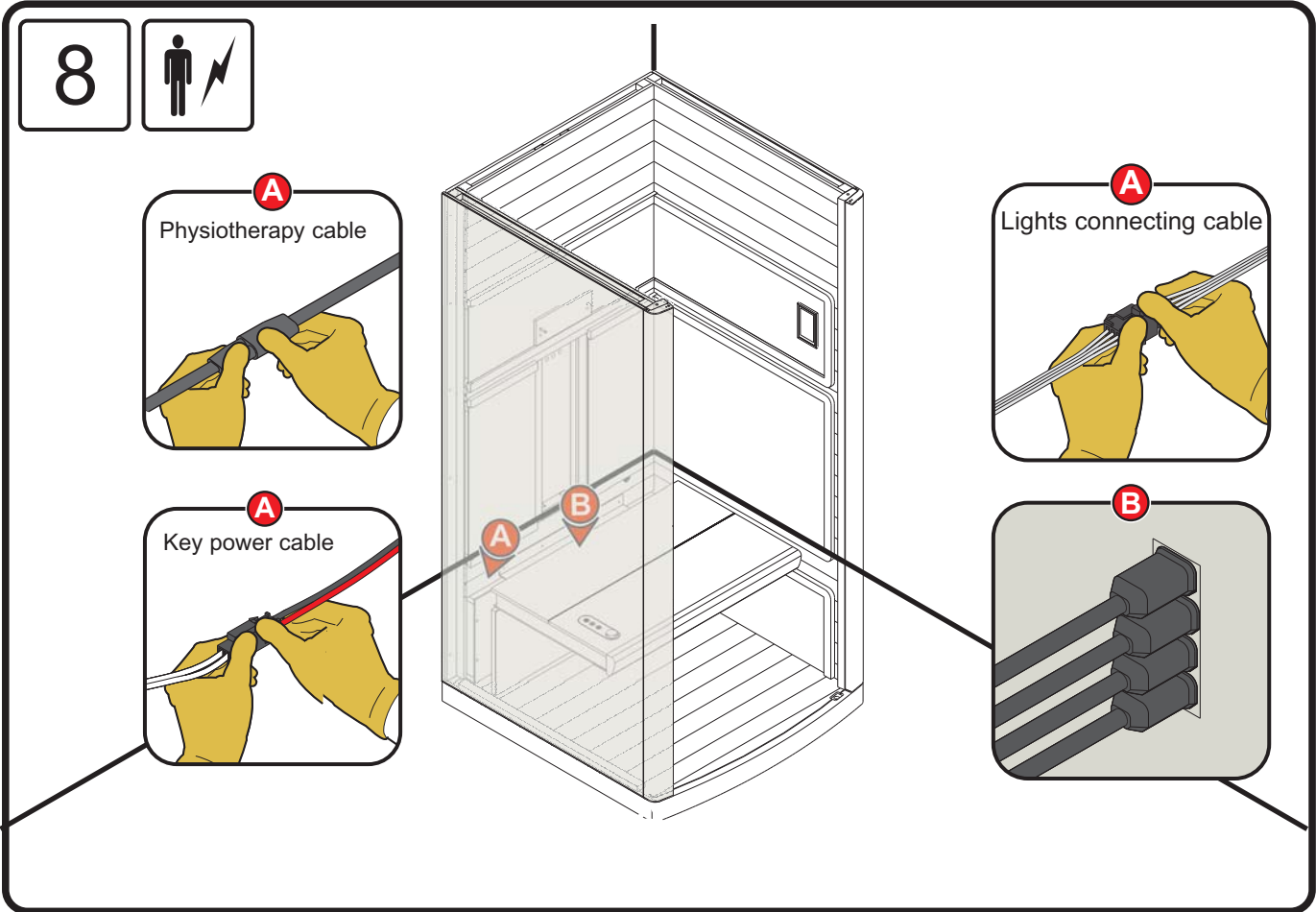
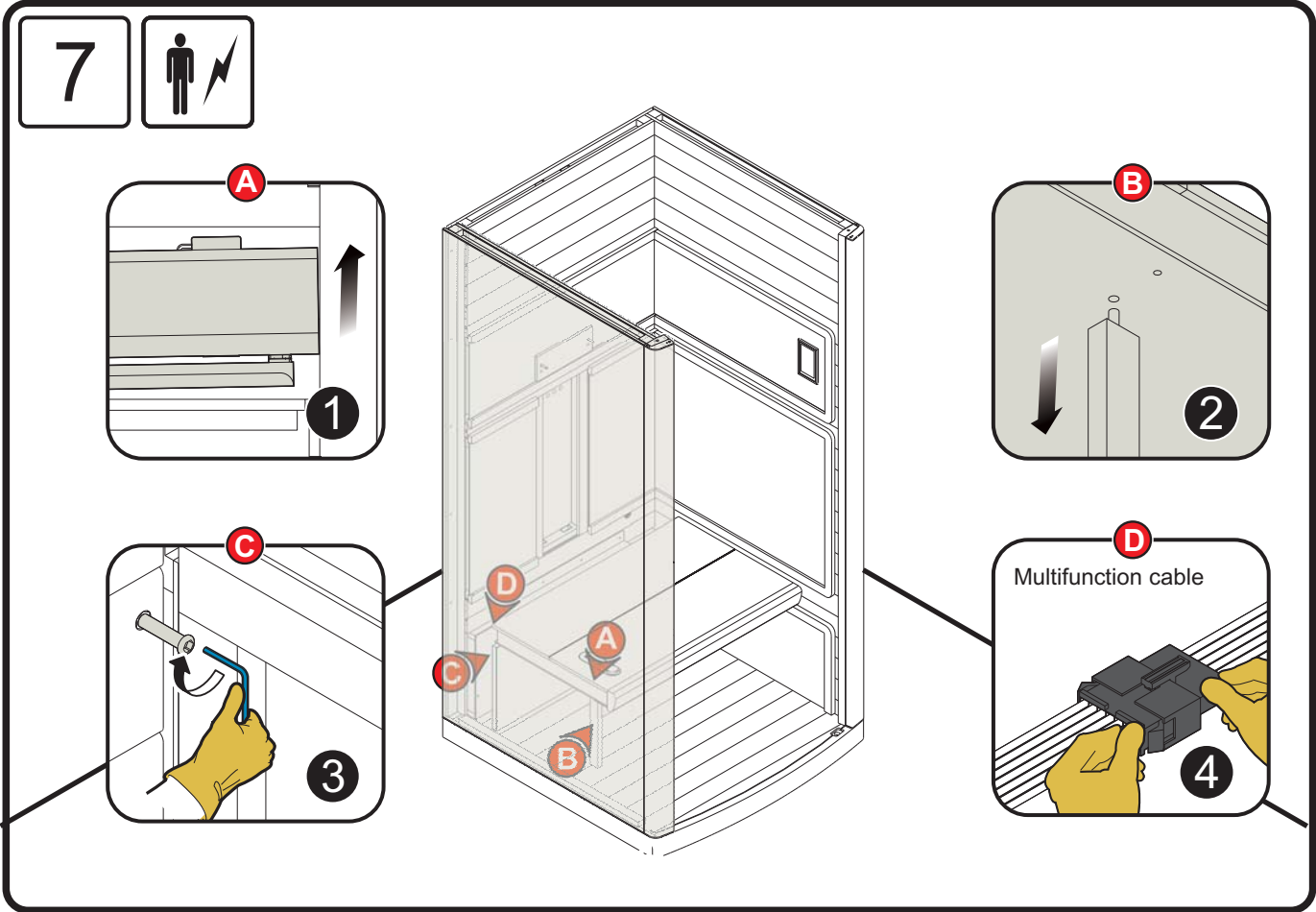

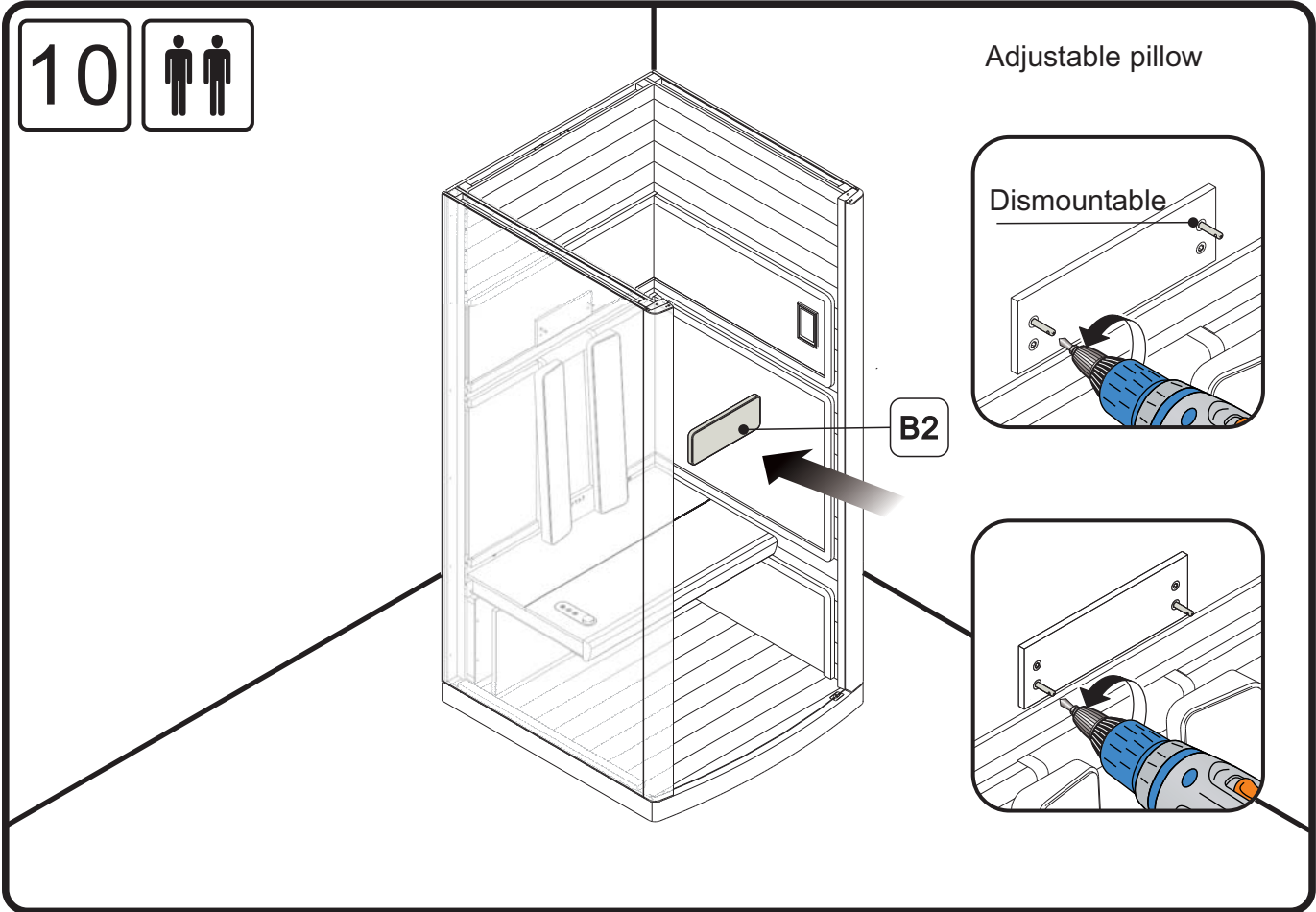
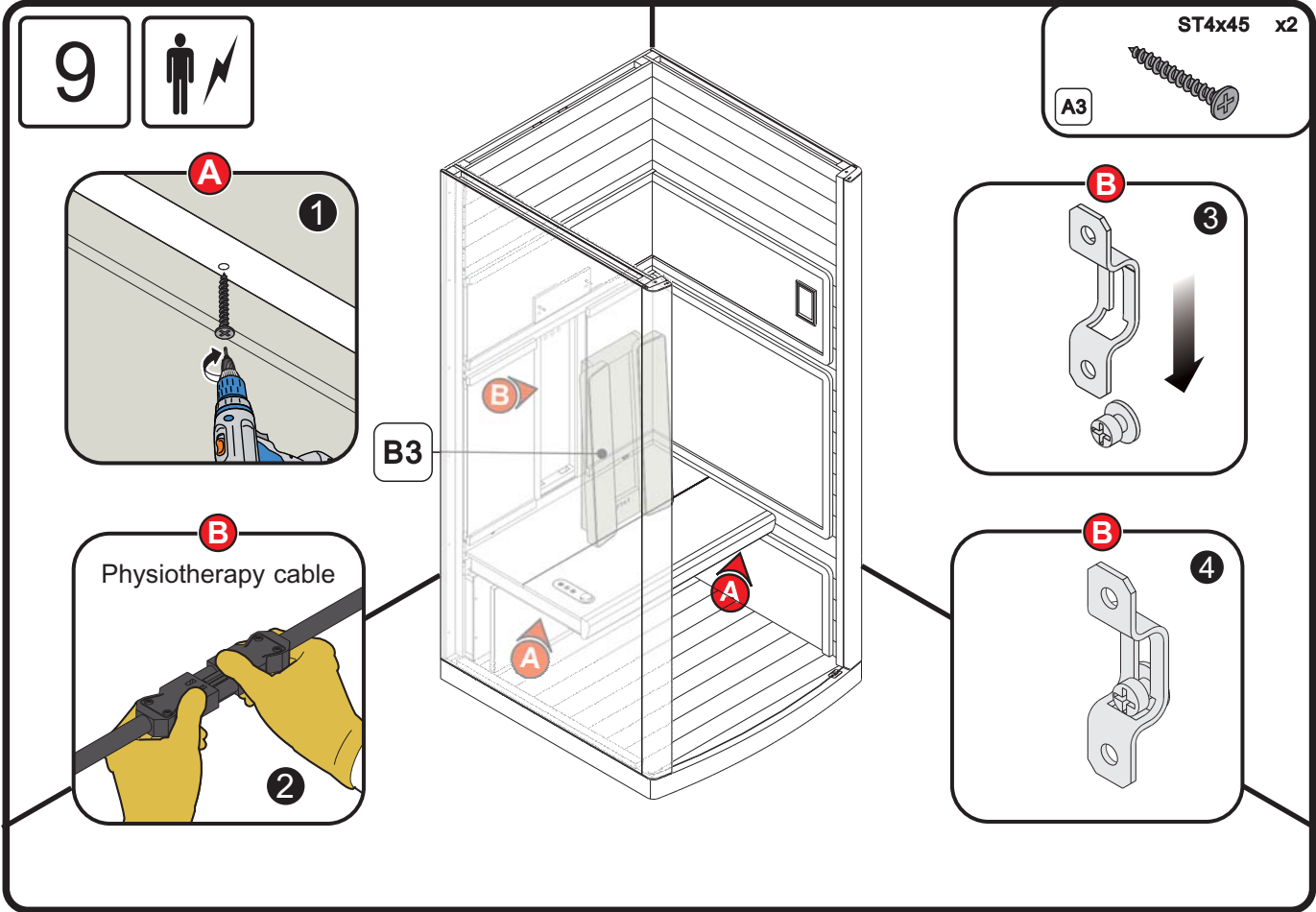

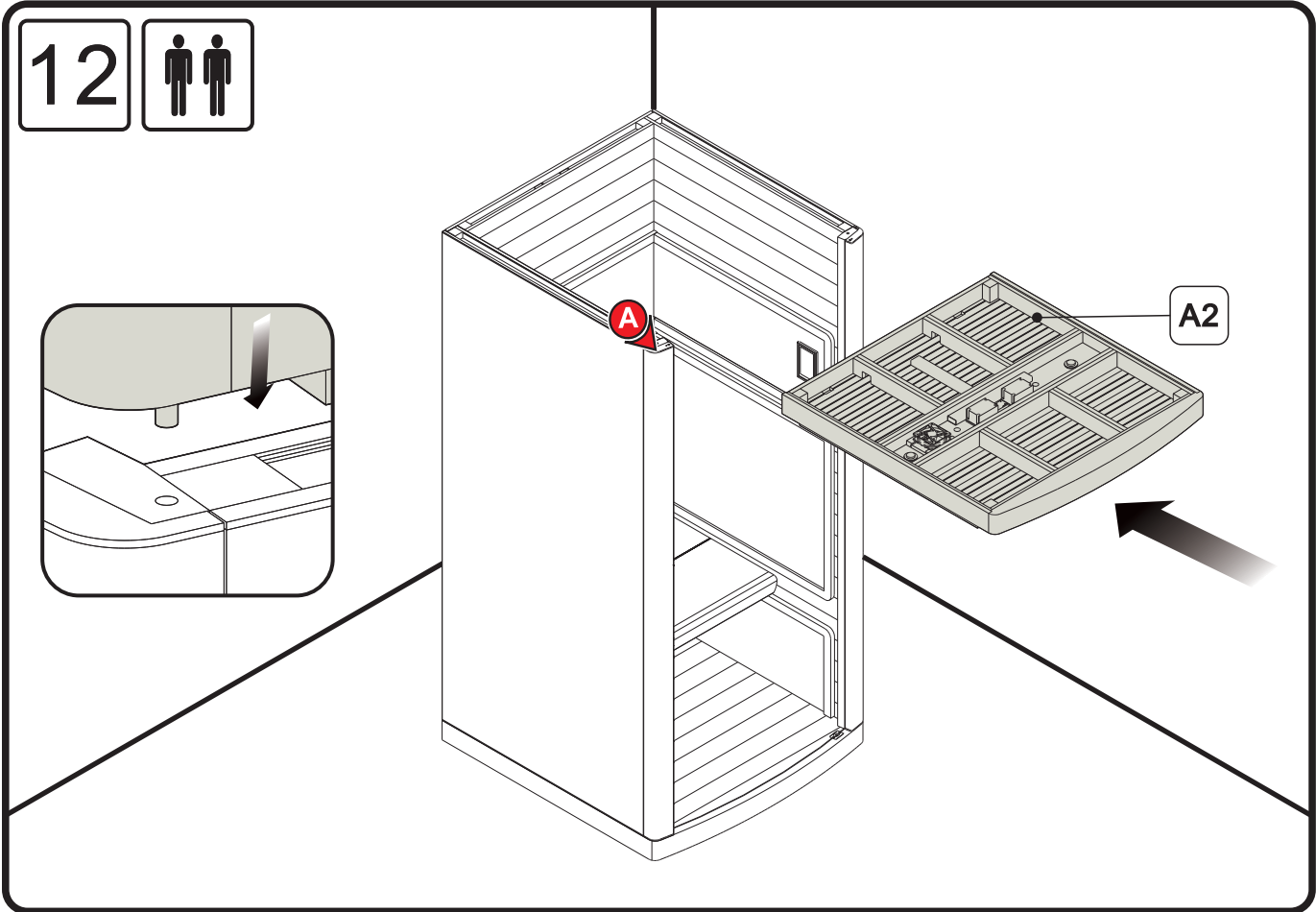
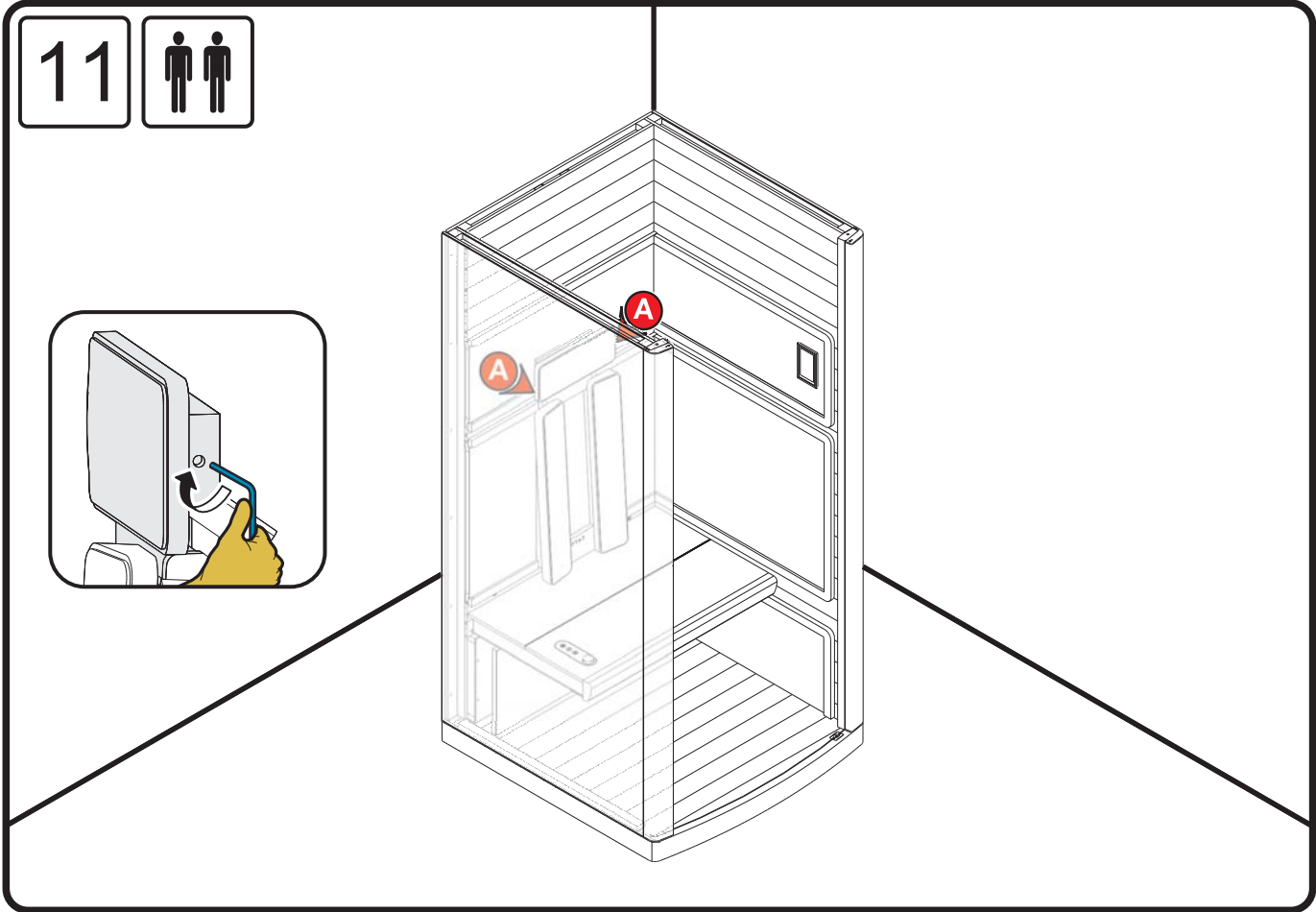

13

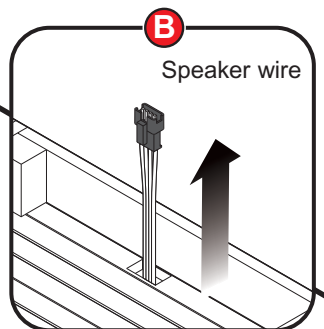
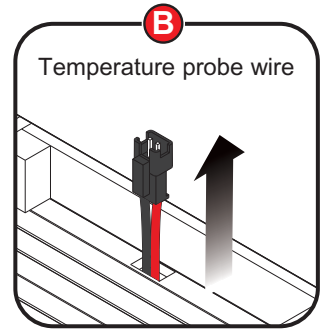
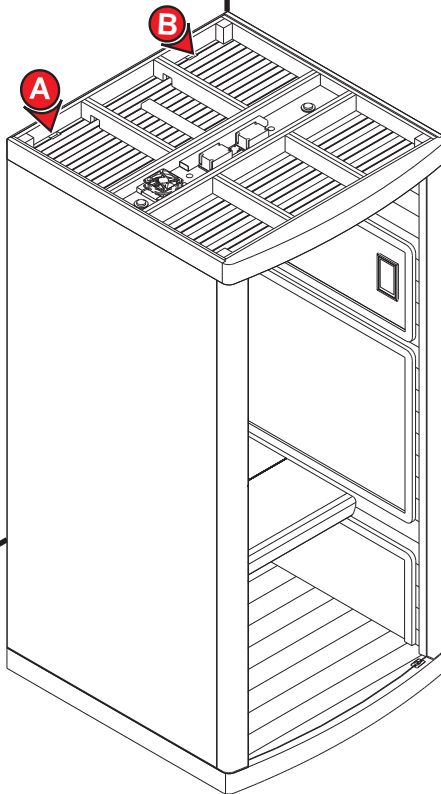
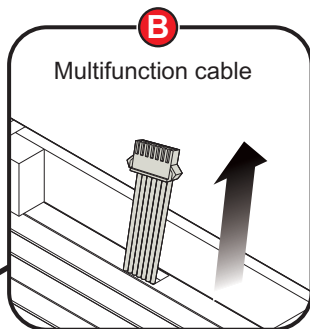
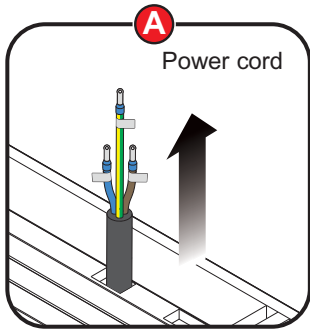

14

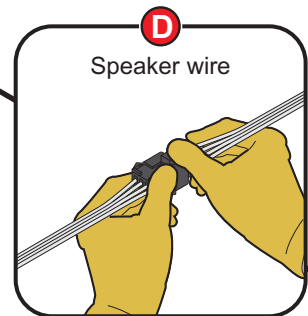
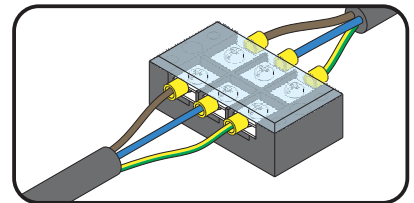
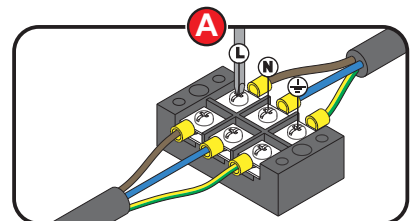
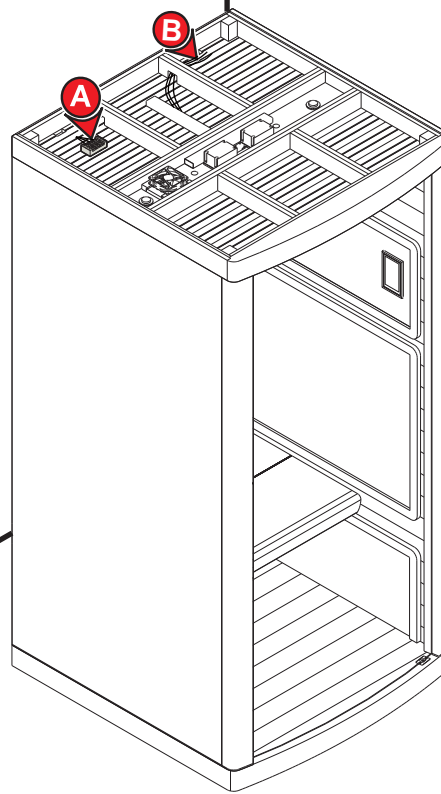
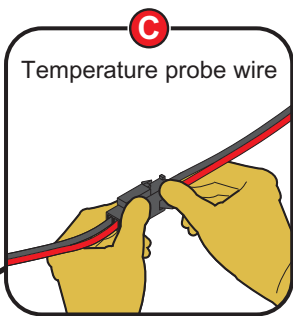
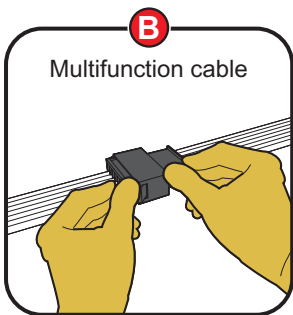

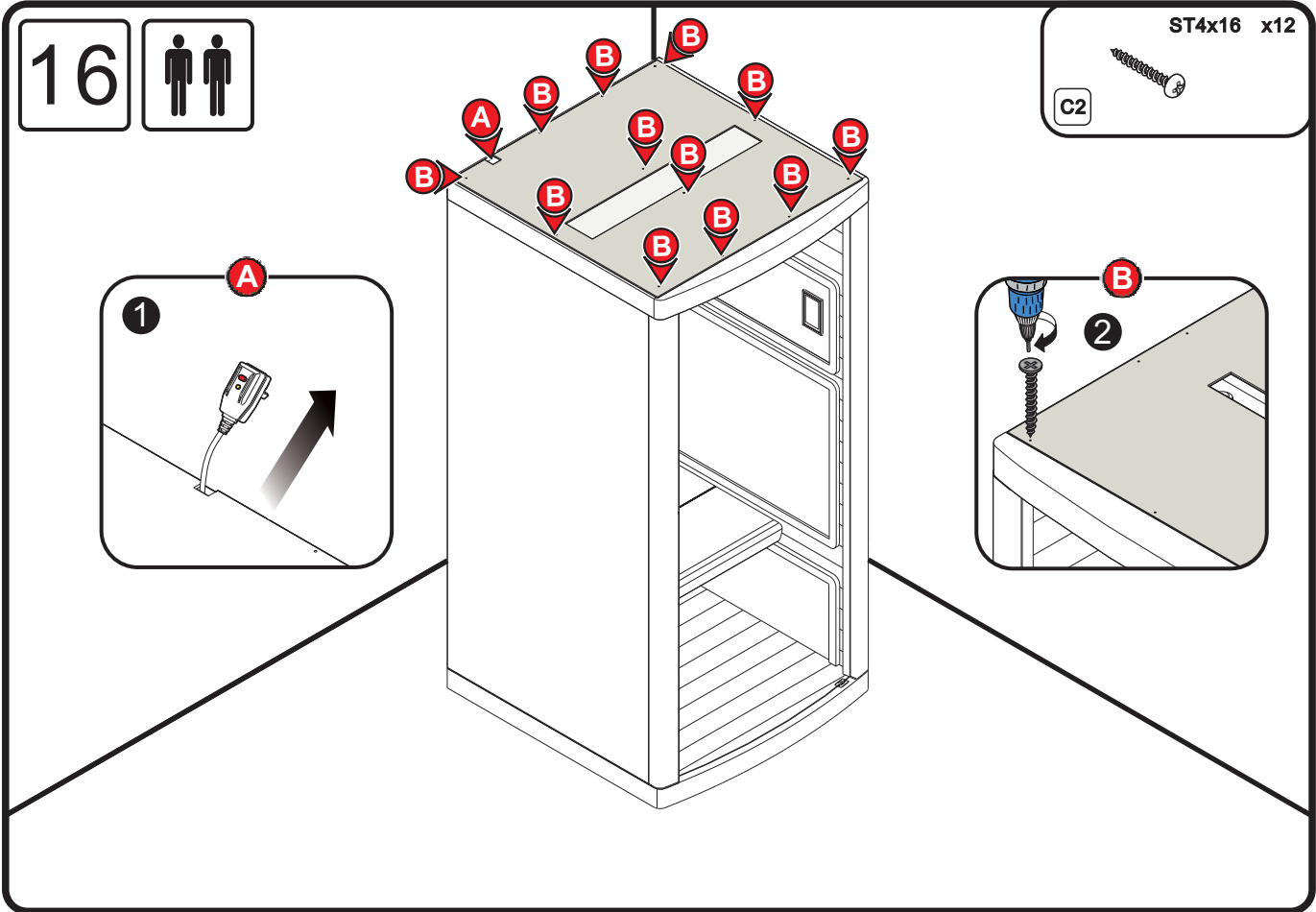
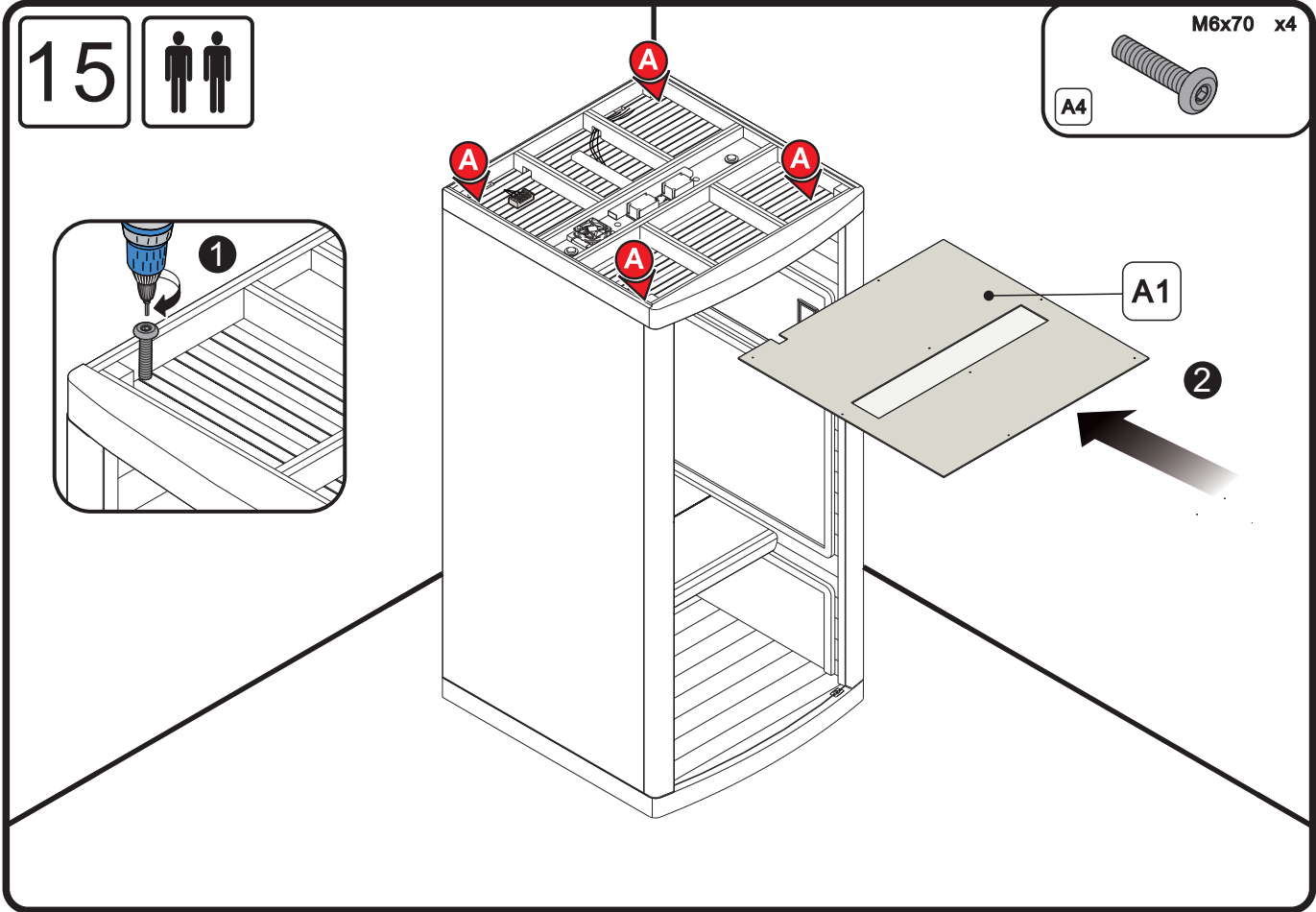

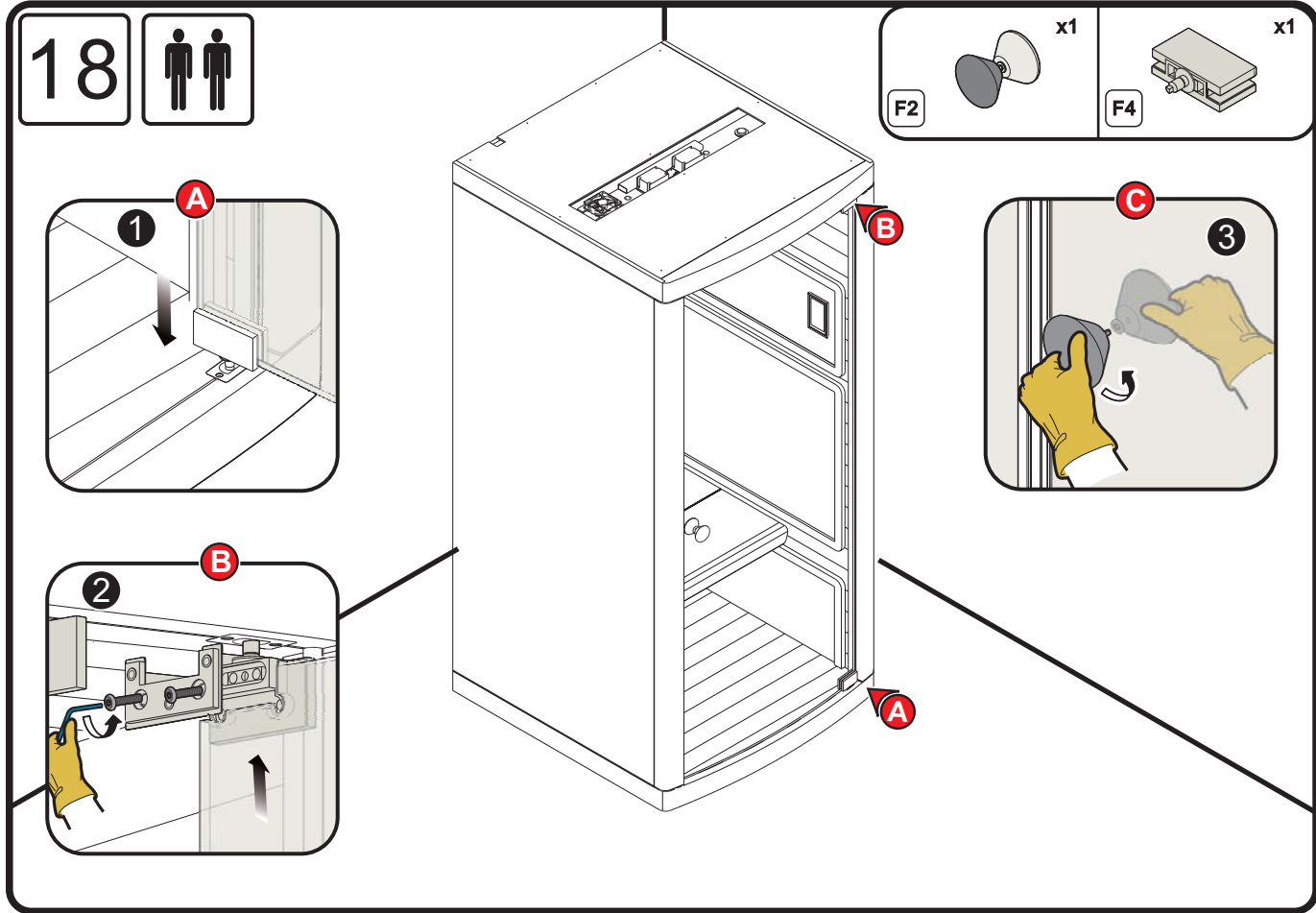
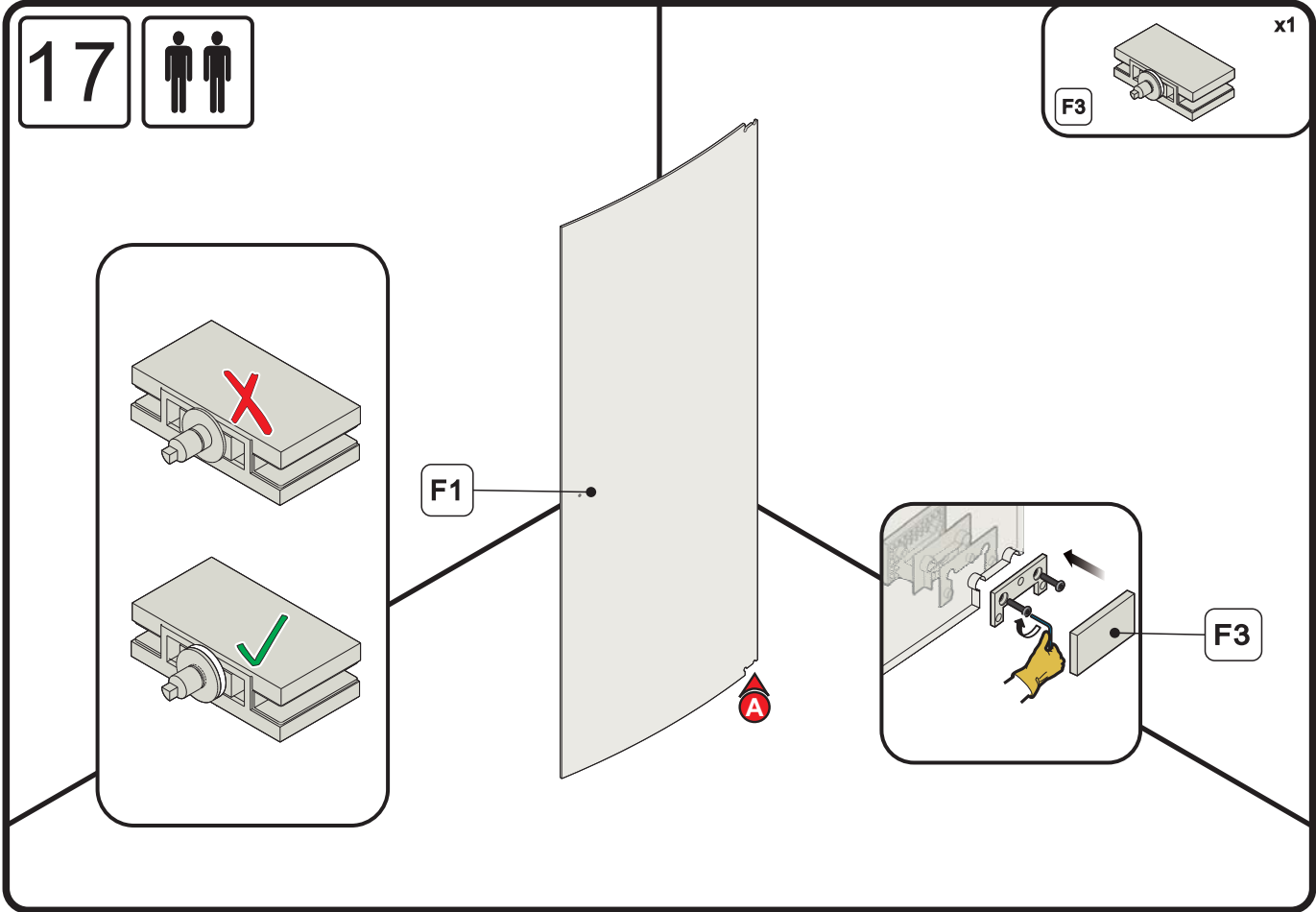

19

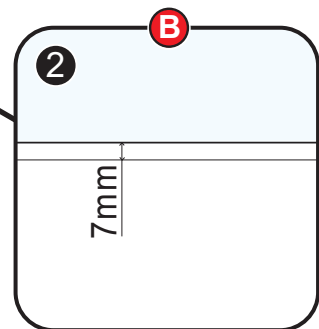
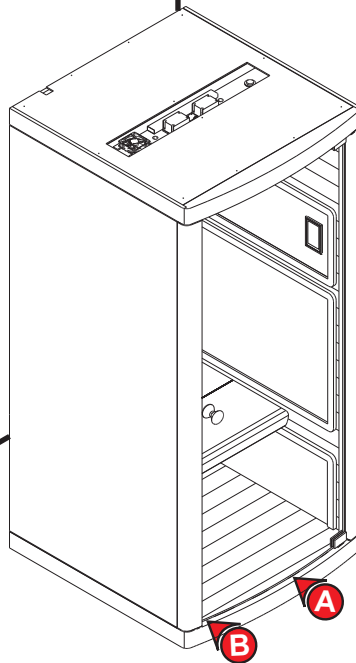
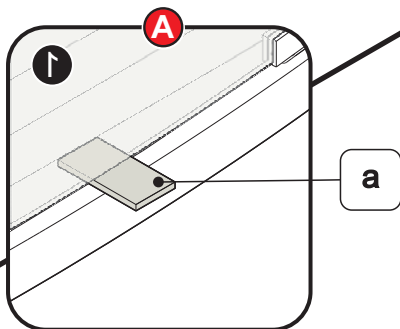

20

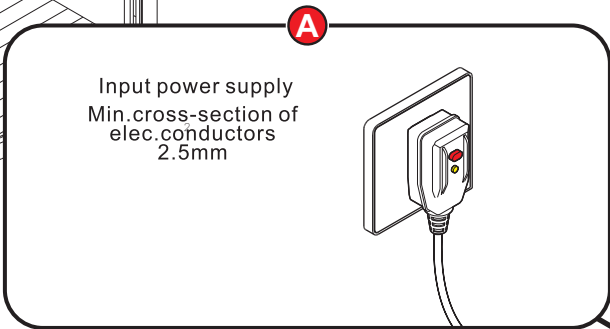
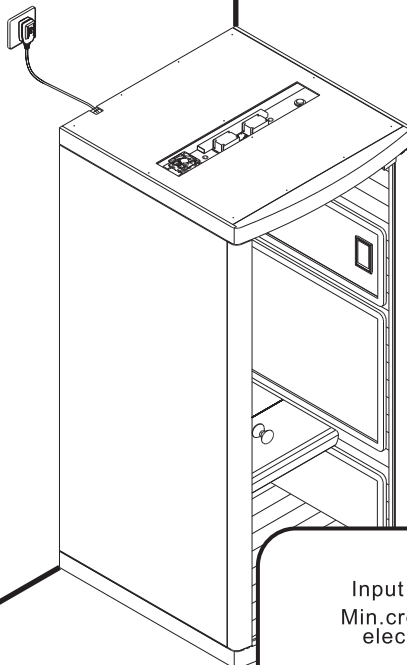

Steam control system operation instructions

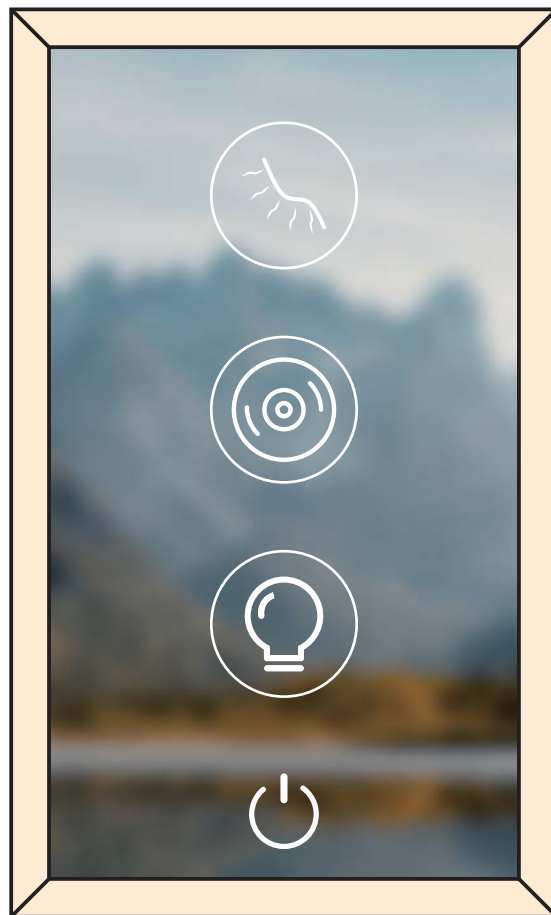

One、 Operating instructions

1.Standby mode:

When the product is in power standby, the panel displays an “O” icon which is breathing and blinking. This indicates that the current system is powered on and needs to be started.(as shown on the right side.)

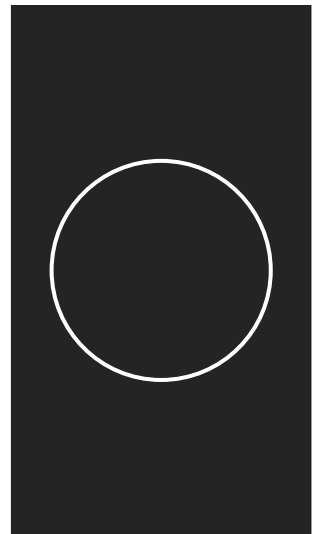

2.Start-up system:



When the system is in power standby state, long press the display screen, and the system will be turned on. (as shown on the right)



3.Steam function



3.1 Select the system default mode

When the system is on, click the sweat function  to enter the sweat preset mode interface. At this time, click the corresponding icon on the interface "Slimming/soothing decompression/detoxification/cell renewal, etc., to turn on the sweat function. (as shown in the picture on the right)

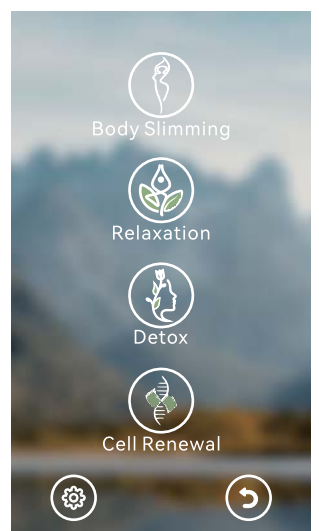
For example, click the icon  to open, and the open status icon is .



3.2 Select custom mode

When the system is in the preset mode interface, click the interface icon  to enter the custom mode, and click the middle icon  to enter the setting interface. Click “+” and “-” under the orange progress bar to set the temperature. The temperature ranges from 25 ° C to 65 ° C. Click “+” and “-” on the green progress bar to set the time, which ranges from 5 to 90 minutes.

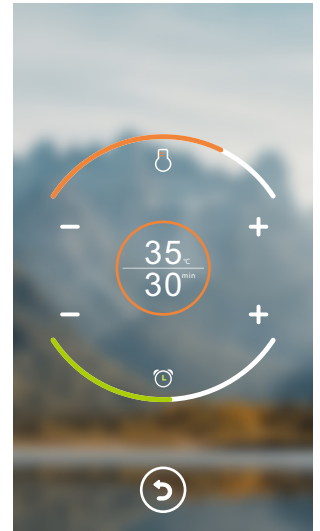



4. Light Function

When the system is turned on, the lights are turned on by default (warm light and color Atmosphere light), then the light icon .

4.1. Warm ambient light on and off

Click the icon  to enter the warm light setting interface (as shown on the right).

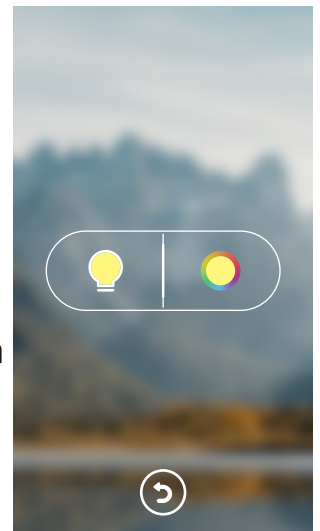

After entering the setting interface, click the icon  to turn off the warm ambient light, This icon is in the status .





4.2 Color ambiance light setup

Click the back icon  to enter the color atmosphere light setting interface (as shown on the right).

After entering the setting interface, click the color on the color ring to set the color of the atmosphere light to the current color.

Long press the middle icon  to set the automatic cycle color change mode. After the setting, the icon  is displayed.

Click the icon  to turn off the color atmosphere light. After turning off the atmosphere light, the icon  will be displayed.

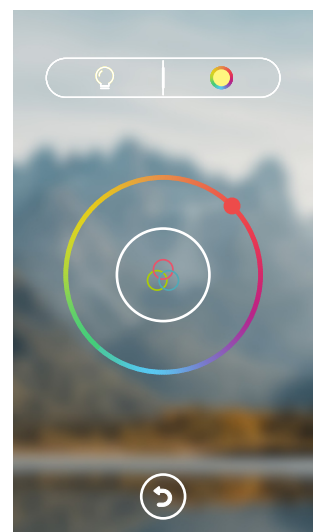

5. Bluetooth music function

When the device is powered on, click the icon  to access the Bluetooth connection screen.

Click the icon  to enter the Bluetooth search mode, use your phone to open the Bluetooth search function, and search for the Bluetooth name "BT-sauna" for the sauna connection. (As shown on the right)

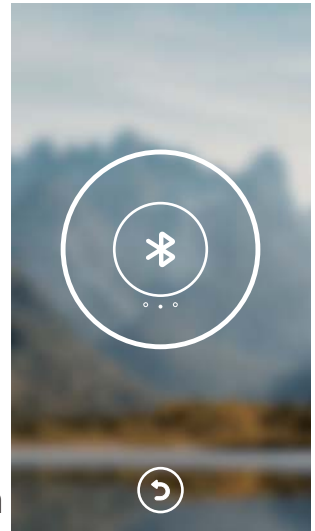

When the Bluetooth connection is successful, the system will display the Bluetooth player interface (as shown in the picture on the right).

Volume Adjustment: Click  and  icon to adjust the volume.

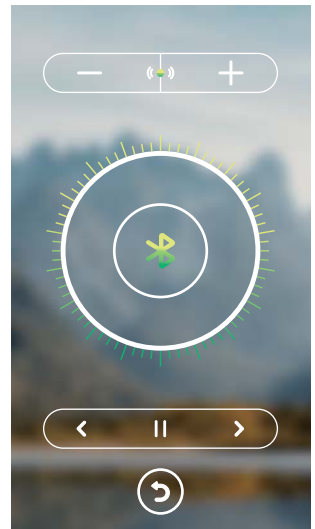



Music Play: Click the icon  to play the next song.

Click the icon  to play the previous song.

Click the icon  to play and pause a song.

Click the icon  to turn off the Bluetooth music function.

6. Turn off the system

On the main page of the system, click the icon  to enter the turn off confirmation state. At this time, clicking this icon  will shut down and enter the standby state.

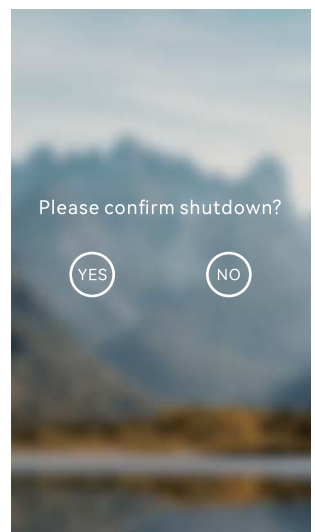

7. Ozone disinfection function

If no operation is performed within one minute after the system is shut down, the system automatically enables the ozone function for one minute, and automatically shuts down when the time expires.



8. System outage

If the product is not used for a long time, it is recommended to power off the entire product through the home master control switch or the product comes with the master control switch.

Central control operation instructions

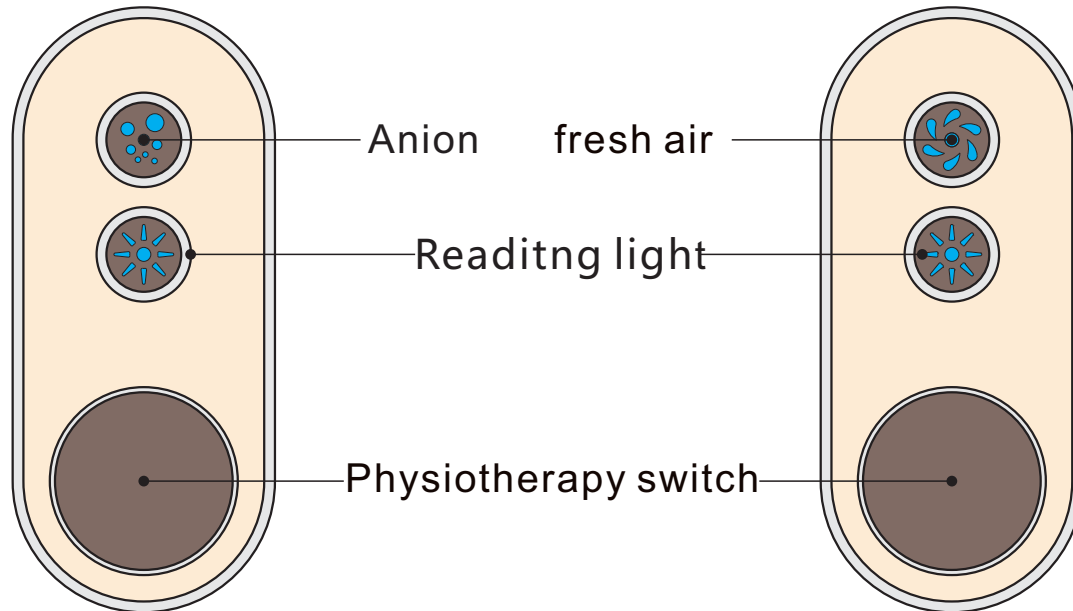

1. Physiotherapy switch

Press the physiotherapy switch, the switch will spring up, then rotate the physiotherapy switch to start the physiotherapy and adjust the intensity of the physiotherapy, otherwise close.

2. Reading light

When the system is in standby state, the reading light is displayed in blue. Press the button to enable the reading light function, and press again to disable it.

3. When the system is in standby state, the negative ion function is displayed in blue. Click the button to turn on the negative ion function, and press it again to turn off.

4. Fresh air exchanger

When the system is in standby state, the fresh air function is displayed in blue. Click the button to open the fresh air function, and press again to close it

 **Rans**